

REGION OF OTTAWA-CARLETON
RÉGION D'OTTAWA-CARLETON

REPORT
RAPPORT

Our File/N/Réf. Your File/V/Réf.	50 20-99-0084
DATE	31 May 1999
TO/DEST.	Co-ordinator Transportation Committee
FROM/EXP.	Director Mobility Services and Corporate Fleet Services Environment and Transportation Department
SUBJECT/OBJET	GLEBE COMMUNITY ASSOCIATION REQUEST FOR WELCOMING SIGNAGE ON BRONSON AVENUE

DEPARTMENTAL RECOMMENDATION

That Transportation Committee recommend Council approve the installation of welcoming child figures and bilingual “Welcome to our Neighbourhood” signs on Bronson Avenue as proposed by the artist Bhat Boy and the Glebe Community Association.

BACKGROUND

In the fall of 1998, two public meetings were held to identify traffic issues that local residents wished to see addressed in the Glebe Area Transportation Study. During the first meeting attended by 55 residents, the Ward Councillor explained that traffic calming funds were scarce and staff stressed that in view of that limitation, it was likely that only those issues which residents were prepared to lend a hand in, by conducting traffic surveys themselves, could be studied. Each attendee was then given a ballot on which to note the four local transportation issues of greatest concern and the responses were summarized to reflect the concerns of the community as a whole.

At the second meeting, over 80 residents were on hand to continue the process. Based on their understanding of the issues, the days and time periods best suited to confirm each were set out and manpower needs determined. Staff provided instructions, field sheets and all required equipment, but it was left to the community to recruit the necessary survey help. In the spirit of working together to solve problems, staff challenged residents not only to collect accurate and representative data to confirm the problems, but also to consider options to solve them.

It should be noted that at that point in time, the study had not been approved for funding and residents feared that if they waited until it was, through the 1999 Regional budget process, more time would be lost as the appointment of a consultant would not take place until the summer of 1999. By then, Carleton University would have recessed and since some of the issues were impacted by traffic it generates, the collection of representative data would have to wait until the fall of 1999. Rather than wait until then, their only recourse was to collect it in the late fall of 1998. Despite the cooler temperatures and reduced daylight which prevailed at that time of year, they were able to recruit more than 100 volunteers to complete that work by the end of November 1998.

As a result of that process, which in part involved the gathering of speed data using radar guns supplied by this Department, residents were challenged to consider among other things, options to slow the traffic on Bronson. While they recognized that physical changes to infrastructure would have to await completion of the study and approval by Council, they were nonetheless anxious to propose interim solutions.

To that end, the artist Bhat Boy proposed a concept whereby approximately 25 brightly-painted plywood figures depicting children at play would be affixed to utility poles on both sides of Bronson between the Canal and the Queensway. They would remind drivers in a cheerful, non-confrontational way that they were travelling through a residential community and be augmented at both ends of that road section with entry signs displaying the message "Welcome to our Neighbourhood - Bienvenue à notre quartier." To maximize community involvement in the project, plywood and paint costs (approximately \$2,500 in total) would be solicited through private donations and all signs and figures would be painted by local high school students.

The Glebe Traffic Committee endorsed the proposal and in turn asked Ottawa Hydro for permission to mount the signs and figures on their utility poles. Hydro concurred and the Glebe Community Association forwarded the proposal to the Region, asking that Regional staff assist in the project by cutting the figures out of the plywood supplied by the community (as that task would require use of a fairly robust band saw), by affixing the signs and figures to the utility poles, and by extending the Region's municipal insurance to cover the signs and figures. Copies of that correspondence are attached as Annex A.

During the Transportation Committee meeting of 05 May 1999, the proposal was raised as an inquiry by the Ward Councillor. Staff responded through a brief presentation, noting in part that public safety is everyone's responsibility and that in developing open and sincere partnerships with community groups, every possible consideration must be given to suggestions they put forward.

It was staff's view at that time that this proposal had genuine merit; however, without having had the opportunity to assess it in detail, there appeared to be two possible implications. First, the brightly-painted figures might distract driver attention and second, since the figures were to be fabricated from (rigid) ¾" plywood, they would conflict with the Signs By-law. It states in part that "No person shall place or cause to be placed on a Regional Road ...a rigid sign, other than an election sign or a special event sign".

Notwithstanding those concerns, it was staff's opinion that the proposal should be viewed as a traffic-calming initiative and that every effort should be made to accommodate it. It was noted that the signs and figures would be mounted several feet off the ground so as not to interfere with pedestrians, and, as each figure would be unique in shape and colour, care would be taken to ensure that those located near regulatory and warning signs, and especially those near traffic signals, did not conflict with those devices in terms of visual conspicuity. It was also noted that estimated costs to the Region would be limited to \$250 for shop work and \$1,000 for installation.

Based on that information, Councillor Doucet proposed that Committee agree with the concept and asked staff to report back on the proposal in June. This would provide the Glebe Community Association with a positive indication and enable them to commence fund-raising activities and recruitment of student help before the summer recess. One Committee member was reluctant to approve the Motion in view of the implications which could arise if other communities came forward with similar requests and it was suggested that this could be discussed further when the staff report was presented.

DISCUSSION

Since then, staff have reviewed each and every utility pole on this portion of Bronson and have met on-site with the originator of the proposal. Those assessments reveal that there are currently 11 poles on the east side and 8 on the west onto which the proposed signs and figures could be mounted. It may be possible to increase those numbers slightly, by consolidating discretionary signage such as highway route markers and hospital signs, but for the most part those numbers are fixed as there are no utility poles on the west side south of First Avenue and many of the poles not currently used for signs are shrouded by tree foliage.

Further, the review eased earlier concerns that the proposed signs and figures could distract driver attention near traffic signals - all utility poles in close proximity to those devices are currently used to display regulatory or warning signs; therefore, since none of those signs can be moved, there are no opportunities to install the proposed signs and figures on poles near signals.

It also works out that most poles on the east side of Bronson which could accommodate figures are in the southerly half of the Canal to Queensway section, and those available for figure mounting on the west side are in the northerly half of that section. This means the figures would be concentrated near the start of the community, whether entered by northbound or southbound commuters. That coincidence was discussed with Bhat Boy and he expressed confidence that deployment of the figures at those sites, rather than posting them uniformly throughout that section, would probably increase their effectiveness.

With respect to implications arising from the fact that the signs and figures would be rigid and therefore, not permissible under the strict interpretation of the Signs By-law, our Legal Department has advised that provisions of that By-law do not apply to the Region's signs and therefore, by extension, to signs installed by the Region.

Regarding the notion that other communities may come forward with similar requests, it is our view that provided those requests are submitted in good taste, have strong community support, and demonstrate similar regards for message statement, size, material, mounting location and colour, they too should be endorsed, subject to availability of funds. In fact, if everyone in the Region understood that measures of this type represent an honest response on the part of local residents to concerns for public safety in light of excessive speeds within their community, it might encourage sympathetic drivers to respect those concerns and slow down.

The signs and figures set out in this proposal cannot be viewed in anyway as being official or regulatory - they simply remind drivers that they are travelling through a residential area and hopefully, elicit a response that they should do so in a courteous and responsible way. If more communities were to put forth similar efforts in canvassing for funds, painting signs and figures and reporting on the problem in local newspapers, then over a period of time that groundswell of emotion could raise public awareness to the sensitivity of the issue and translate into more respectful operating speeds.

In summary then, it is the view of this Department that the Bhat Boy proposal is a good one, that the artist who conceived it should be commended and that all reasonable efforts should be made by Regional staff to assist the Glebe Community Association in the implementation of this project.

FINANCIAL IMPLICATIONS

As noted previously, there would be no expenditure of Region funds for materials to implement this proposal; however, labour costs associated with the request would amount to approximately \$250 of staff time for shop work and \$1,000 of staff (and equipment) time to install the proposed signs and figures. These costs will be absorbed within the Department's existing budget allocation.

*Approved by
Doug Brousseau*

JFB/sc

Attach. (1)



ANNEX A

CLIVE DOUCET

Regional Councillor ♦ Conseiller régional
Capital Ward ♦ Quartier Capitale



111, rue Lisgar Street (Ottawa) Ontario K2P 2L7
Telephone/Téléphone: 613-560-1224 ♦ Fax/Télécopieur: 613-560-6077
E-mail/Courrier électronique: doucetcl@rmoc.on.ca

20 April 1999

Mr. John Kane
President
Glebe Community Association
191 Holmwood Street
Ottawa ON K1S 2P3

OTTAWA-CARLETON ENVIRONMENT & TRANSPORTATION DEPARTMENT	
MSES / DB / G m	
APR 30 1999	
FILE NO.: 09-99-0084	
REC. NO.: 2716	
FILE:	COPIES SENT TO: DB-attach only-not this letter

Dear John:

Thank you for your recent letter with proposals for a driver-friendly traffic calming project, a civility campaign and welcoming signs for the Glebe.

I support the idea of brightly-coloured plywood figures of children mounted to Hydro poles and welcoming signs. Your proposal has been forwarded to Doug Brousseau, Acting Commissioner of Transportation for consideration and I hope to receive a favourable response very soon.

I am anxious that this project receive the support required from the Region as it is the kind of inspired, local, low cost community initiative we should be partnering with. Please let me know if I can be of any more help with this project.

Sincerely,

Clive Doucet
Regional Councillor, Capital Ward

CC:
R. Chiarelli
Chair, Region of Ottawa-Carleton
M. J. E. Sheflin
Commissioner of Environment and Transportation
D. Brousseau
Acting Commissioner of Transportation

dc/sc

Glebe Community Association

191 Holmood Ave.
Ottawa, Ontario K1S 2P3
235-1782
Fax: 998-4492

Clive Doucet
Councillor, Capital Ward
Region of Ottawa Carleton
111 Lisgar St.
Ottawa
K2P 2L7

Dear Councillor Doucet:

As you may be aware, the Glebe has embarked on a traffic review. The review is being undertaken with the support of the Region of Ottawa-Carleton and the terms of reference will be finalized shortly. While the community recognizes that changes to our local transportation infrastructure will likely have to wait until the results of that study become available, the Glebe Community Association (GCA) would like to proceed with a project we call "driver-friendly traffic calming" (see copy of proposal attached), in the meanwhile.

The idea was devised by a local artist, Bhatboy (a member of the GCA Traffic Committee), and involves mounting brightly-painted, plywood figures of children on the hydro poles along Bronson Avenue between the Rideau Canal and the Queensway. There will also be a painted sign at either entry point saying: "Welcome to our neighbourhood/Bienvenue à notre quartier." We hope to have the figures painted by local public and high school students, under Bhatboy's direction, and are in the process of making arrangements with the appropriate authorities. We believe that, once mounted, the figures will provide a cheerful and non-confrontational reminder to drivers that they are passing through a residential community and should proceed in a manner respectful of the safety and well-being of that community:

The purpose of our letter is to request the RMOC's endorsement of our campaign and to seek any permission from the Regional authorities that might be necessary to proceed with the project. Bhatboy has already written to Ottawa Hydro asking for their permission to use the poles. Ottawa Hydro's permission is contingent, in part, on obtaining the appropriate insurance and ensuring the figures will be correctly and securely affixed to the poles (a copy of their response is included with this letter). To this end, we are requesting that the Region mount the figures for us and cover the mounted figures under their municipal insurance policy. We will be undertaking a private fund-raising campaign in the community to cover our anticipated \$2,500 material and production costs.

As you know, there is considerable concern over what is perceived by many citizens as increasingly belligerent and disrespectful driver behaviour and a less than rigorous police

Glebe Community Association

191 Holmood Ave.
Ottawa, Ontario K1S 2P3
235-1782
Fax: 998-4492

enforcement program. At the same time, many of the measures implemented to calm traffic (and drivers) seem only to heighten the level of aggression exhibited by certain members of the driving population and their champions. We at the GCA believe that many (though by no means all) of the problems associated with automobile traffic could be reduced significantly if the *existing* traffic laws were respected. To this end we have also suggested to Deputy Chief Mackie that the Regional Police sponsor a lively and good-natured driver re-education/civility campaign designed to engage the whole regional community. A description of that campaign proposal is appended, for your information. Such a campaign might be billed as a "driver meet your neighbour" or "welcome to the neighbourhood" campaign. Our 'hydro-pole' project is put forward in the same spirit.

We are writing you, as our Regional Councillor, both to solicit your personal support and to seek your guidance on how to proceed. Thank you for your kind attention to this matter. We look forward to your response at your earliest possible convenience.

Sincerely,

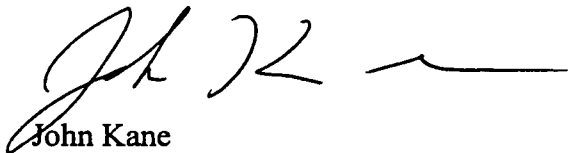

John Kane
President, Glebe Community Association

c.c.:

Mr. Bob Chiarelli
Chair, Region of Ottawa-Carleton

Diane Holmes
Chair, Regional Transportation Committee

Mayor Jim Watson
Ottawa

Inez Berg
Councillor, City of Ottawa
Capital Ward

Deputy Chief Mackie
Ottawa-Carleton Regional Police

March 22nd 1999

To the members of the GCA,

The Glebe, as a community, is concerned about the increase in traffic volume in our neighbourhood. The situation has been aggravated in recent years by the expansion of Bronson Avenue. Many commuters drive along Bronson Avenue as if it were an expressway, seemingly unaware that it flows through a *residential* neighbourhood with a high pedestrian and cycle traffic volume. Children must cross Bronson Avenue every day to get to school, yet cars drive along it as if it were the Queensway.

In an effort to effect low cost traffic controls, the Glebe Neighbourhood Traffic Committee is searching for cost effective ways of raising awareness in drivers, and reducing traffic speeds.

I propose that we organize members of the community to paint wooden cutouts of children to mount onto telephone poles along the stretch of Bronson lying between the Queensway and the Canal as a means of drawing drivers' attention to the fact that they are now driving through a residential neighbourhood. The benefits to the community would be many, among these:

- a cost effective approach to a traffic calming which will not offend drivers;
- beautification of an somewhat bleak stretch of regional road; and,
- an opportunity, for people in our community, to effect change in their own neighbourhood, giving them a sense of self worth as well as an opportunity to learn something about painting.

I am particularly keen on targeting the Conquest Continuum and the Students of Glebe Collegiate. The threat of vandalism may be lowered, by creating an awareness and value for these figures amongst our young people. These and countless other reasons, are evidence that the project would be healthy for our community.

I have received conditional permission, from Ottawa Hydro, to mount the figures on telephone poles. They have sent me a "Memorandum of Understanding" outlining an agreement between the GCA and Ottawa Hydro.

The wooden figures would be mounted on poles using traditional sign mounting equipment, with a metal band secured around the exterior of the column. The figures will start 5 ½ feet off of the pavement, be 4 feet in height and project outwards above head level. The figures will be cut out from ¾ inch plywood and painted. They should present no threat to pedestrians, cyclists or snowplows and have a life expectancy of at least 3 years.

If the GCA agrees to support the proposal, it will be necessary to approach the Region for permission to proceed and possibly for material support (specifically to assist with

mounting the figures and to make their machine shop available to cut out the figures). The Traffic Committee also intends to approach the Regional Police for its endorsement.

Until all of my resources are identified I am unable to give exact specifications in my budget. For example, "Will the region assume the cost of mounting the figures as a contribution to the project?"

I am confident that a budget of \$2,500 will be sufficient to cover the cost of production of 25 or more figures. This will make it more cost effective than most traditional traffic calming measures. The Glebe Traffic Committee intends to approach the Region, the Ottawa-Carleton Police and the City for assistance in this project. Once a budget is approved, the time line for production could be as little as 60 days.

I think that this project is an exciting opportunity to put up a friendly but firm reminder to drivers on Bronson Avenue that the Glebe is a neighbourhood and not a strip of expressway.

Thank you for your time,

Bhat Boy

Figure 1

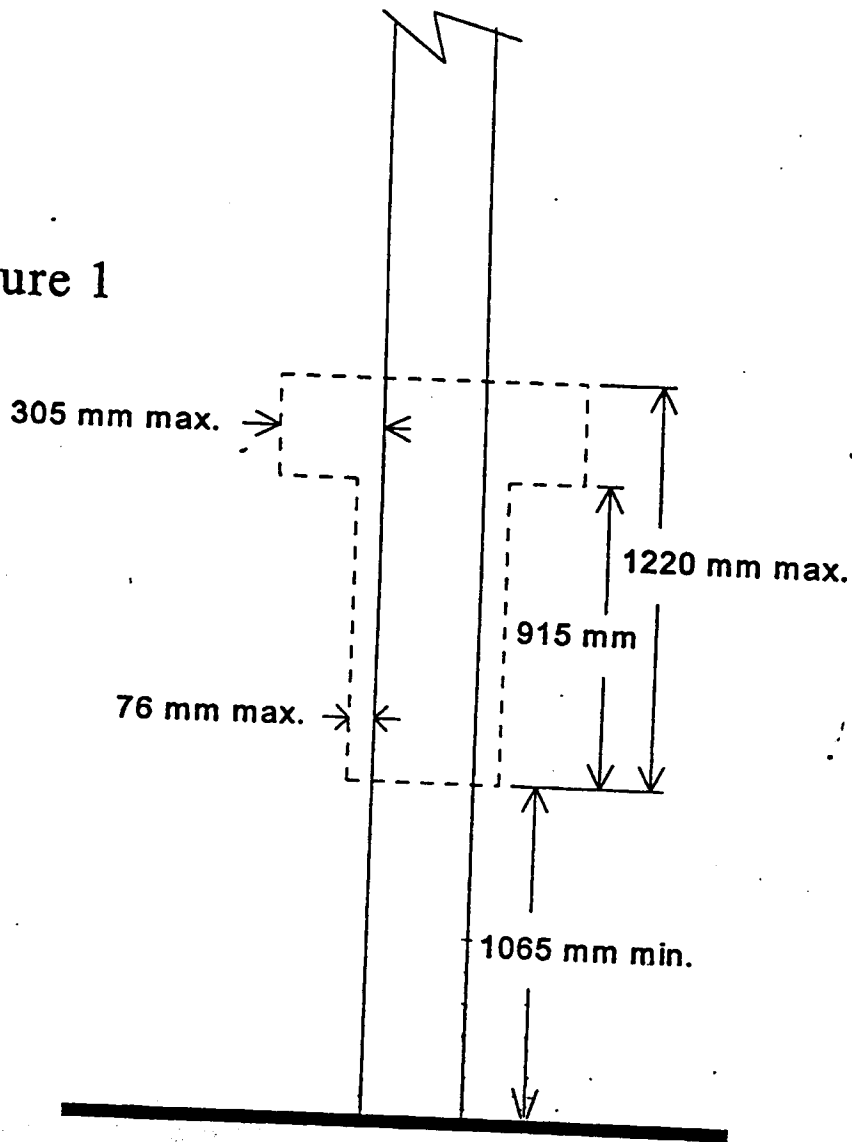

9 1/2 Feet

7 1/2 Feet

5 1/2 Feet

GROUND

figures are based on
1 ft diameter hydro
poles,
4 ft in height,
constructed of
3/4 inch plywood

1999
34

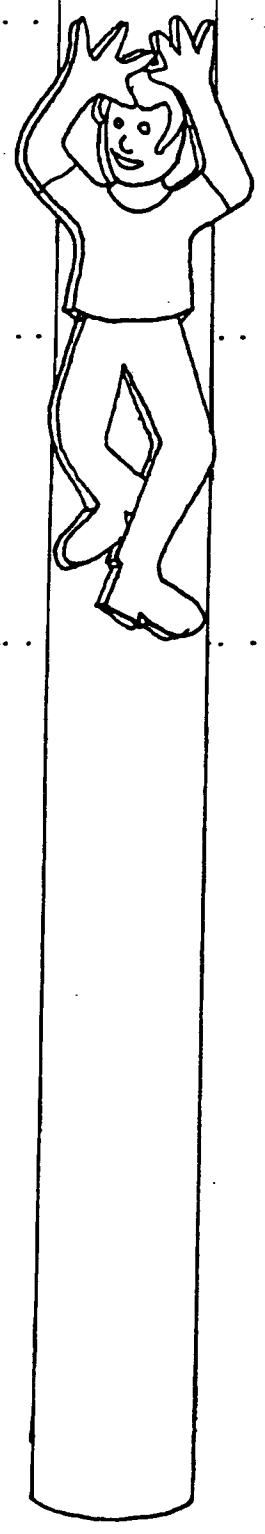
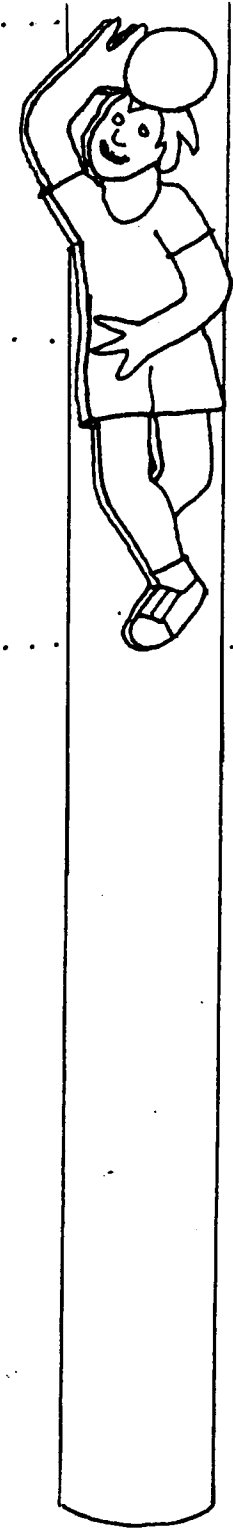
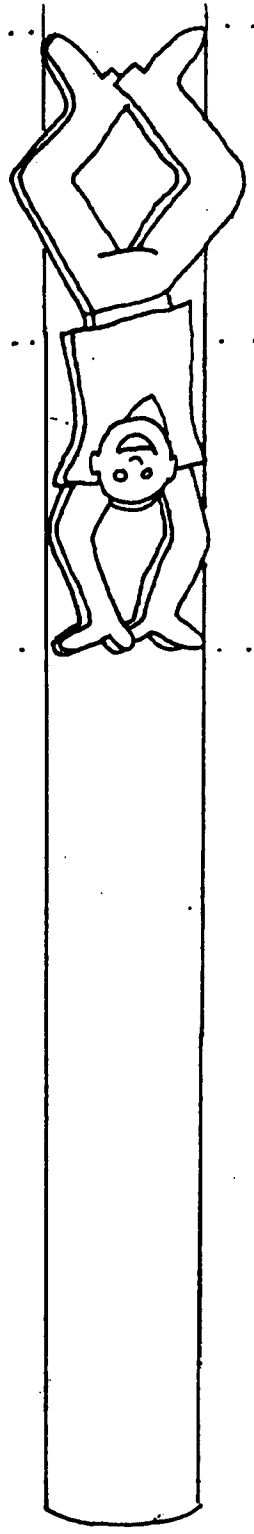
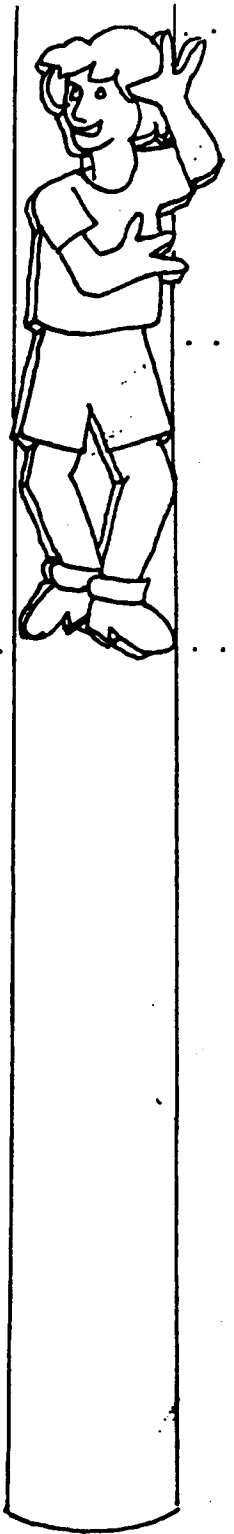

9 1/2 feet

7 1/2 feet

5 1/2 feet

GROUND

figures are based on
1 ft diameter hydro
poles,
4 ft in height,
constructed of
3/4 inch plywood

1999
34

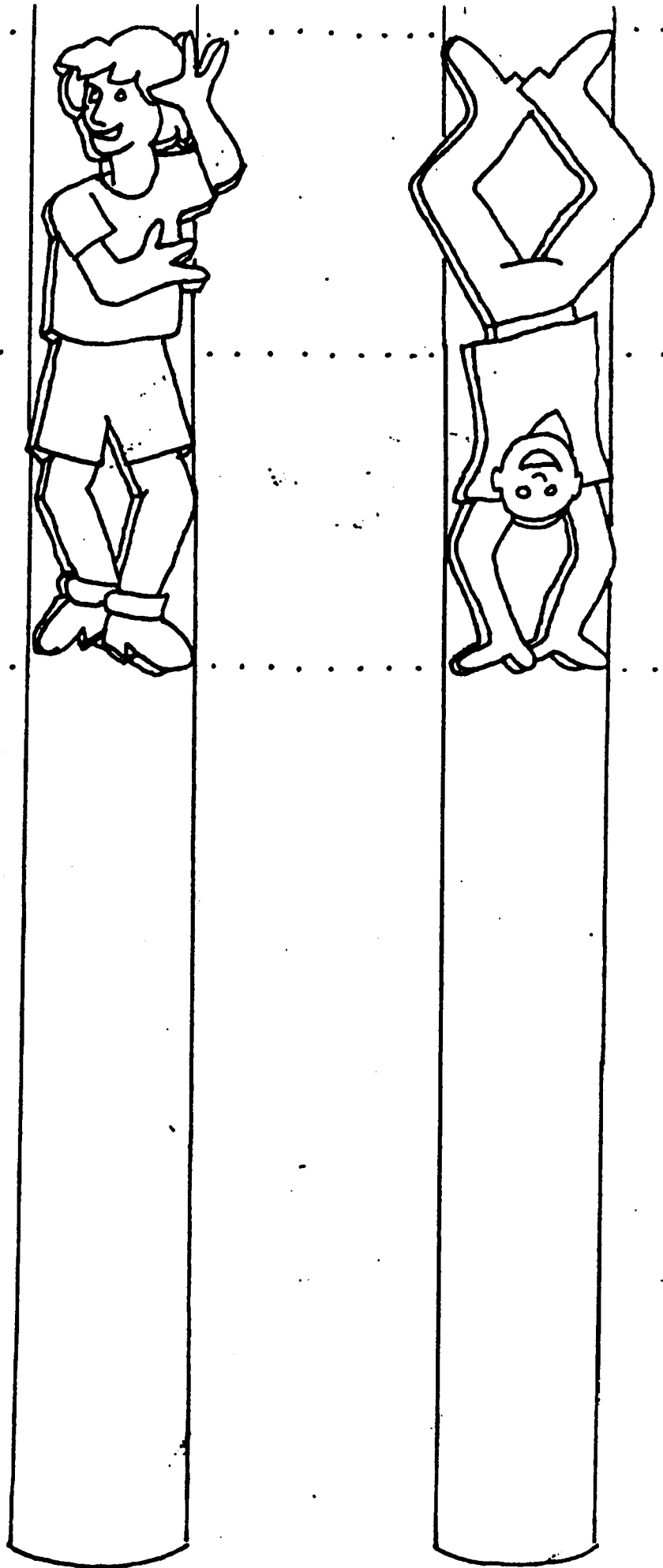



OTTAWA HYDRO

3025 Albion Rd. N / Ch. Albion N
PO Box 8700 / CP 8700
Ottawa, Ontario K1G 3S4
Tel. (613) 738-6400
Fax (613) 738-6402

Chair
Vice-Chair
General Manager &
Chief Engineer
Secretary-Treasurer &
Director of Finance

L. D. Cross
R. J. Kolbus
Carl F. Kropp, P.Eng.
Wil G. Barber, CMA

Présidente
Vice-présidente
Directeur général et
Ingénieur en chef
Secrétaire-trésorier et
Directeur des finances

Copy by e-mail: bhatboy1@hotmail.com

1999-02-26
ENG 6.526

Glebe Neighbourhood Traffic Committee
c/o 612-d Bank St
Ottawa, Ontario
K1S 3T6

Attention: Bhat Boy

Re: Attachments of Wooden Figures of Children to Hydro Poles

I am writing in response to your letter to our General Manager Mr. Kropp, in which you requested our consideration of a proposal to install wooden figures on Hydro poles.

We found your proposal very interesting and Ottawa Hydro is prepared to accept it in principle as long as a few points can be clarified to our satisfaction.

1. Although the proposal did not state it in so many words, we assume that you are interested in attachments on poles only on Bronson Avenue between the Rideau Canal and the Queensway.
2. Ottawa Hydro must deal with a legal entity on this matter, and we assume that in your case it would be the Glebe Community Association.
3. Our standard Memorandum of Understanding (MOU) (copy attached) must be signed by both parties to define responsibilities of each. Please read the conditions carefully and note in particular your responsibility to obtain permission from other agencies before erecting the Figures.
4. Please mark your choice of poles on the pole map included as Figure 2, 3, and 4 in the MOU. Ottawa Hydro will visit the site and determine which of the poles you choose will be satisfactory for mounting the Figures.

I understand that you will be away until 1999-03-10, but on your return I would be pleased to discuss this project with you further. When we have reached agreement on which poles will be used, the MOU will be finalized and signed.

Henry Jaques, P.Eng.
Director of Engineering
613-738-5499 ext 215

Attachment: MOU hsj99A1